

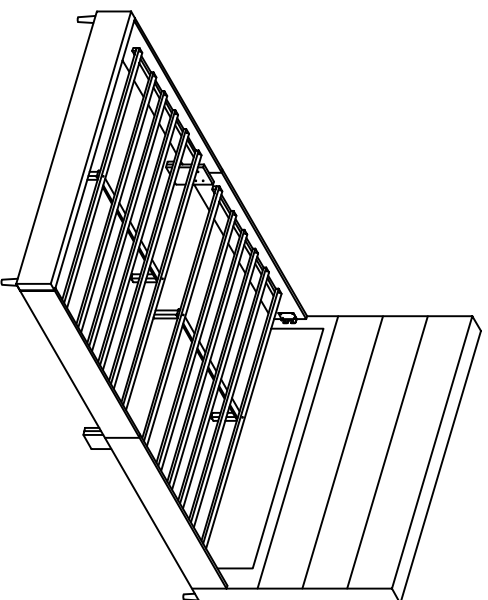

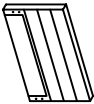













PART LIST / LISTE DES PIÈCES / LISTA DE PIEZAS
 ITEM NO. / ARTICLE NO. / ARTICULO NO. : DS-D393-287 UK
 DESCRIPTION / LA DESCRIPTION / DESCRIPCIÓN : Double Horizontal Channel Bed - Fogg / Lit Double / Cama Matrimonial



- | | | | | |
|---|---|---|---|---|
|  |  |  |  |  |
| x1 Headboard
x1 Tête de lit
x1 Panel de la cabecera | x1 Footboard
x1 Pied de lit
x1 Pie de cama | x4 Footboard leg
x4 Pattes de pied de lit
x4 Patas del pie de cama | x2 Side rail
x2 Côtés de lit
x2 Largueros lateral | x2 Side rail
x2 Côtés de lit
x2 Largueros lateral |

- | | | | |
|--|--|--|--|
|  |  |  |  |
| x2 Center support leg*
x2 Supports centraux
x2 Soportes centrales | x2 Slats*
x2 Lattes
x2 Listones | x4 Stat Support Legs*
x4 Pattes de supports
x4 Patas de apoyo de listones | x2 Center Rail*
x2 Rail Central
x2 Carril Central |

- | | | | |
|--|--|--|---|
|  |  |  |  |
| x8 Allen bolt M8 X 20mm
x8 Vis à tête creuse hexagonale M8 X 20mm
x8 Perno Allen M8 X 20mm | x8 Allen bolt M6 X 30mm
x8 Vis à tête creuse hexagonale M6 X 30mm
x8 Perno Allen M6 X 30mm | x4 Allen bolt M6 X 60mm
x4 Vis à tête creuse hexagonale M6 X 60mm
x4 Perno Allen M6 X 60mm | x8 Flat washer M6*
x8 Rondelle plate M6
x8 Arandelas plana M6 |

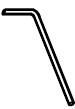
- | | | |
|---|---|---|
|  |  |  |
| x24 Screw M4 X 32mm*
x24 Vis M4 X 32mm
x24 Tornillo M4 X 32mm | x1 Allen Wrench M4 X 65mm*
x1 Cle hexagonale M4 X 65mm
x1 Llave Allen M4 X 65mm | x1 Allen Wrench M5 X 70mm*
x1 Cle hexagonale M5 X 70mm
x1 Llave Allen M5 X 70mm |

* Replaceable Part

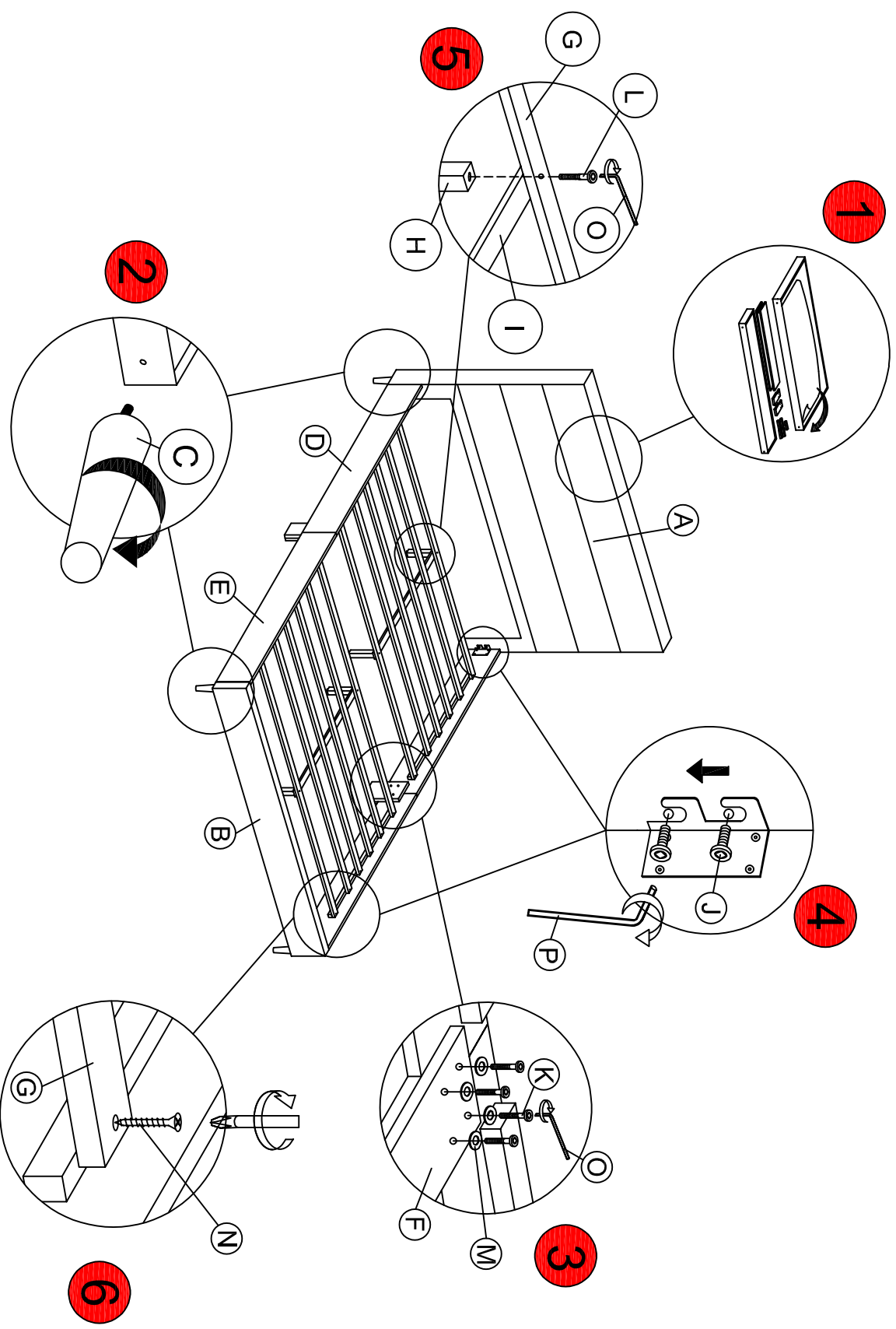



REPLACEABLE PART / PARTIE REMPLACABLE / PARTE REEMPLAZABLE

ITEM NO. / ARTICLE NO. / ARTICULO NO : DS-D393-287 UK

DESCRIPTION / LA DESCRIPTION / DESCRIPCIÓN : Double Horizontal Channel Bed - Fogg / Lit Double / Cama Matrimonial

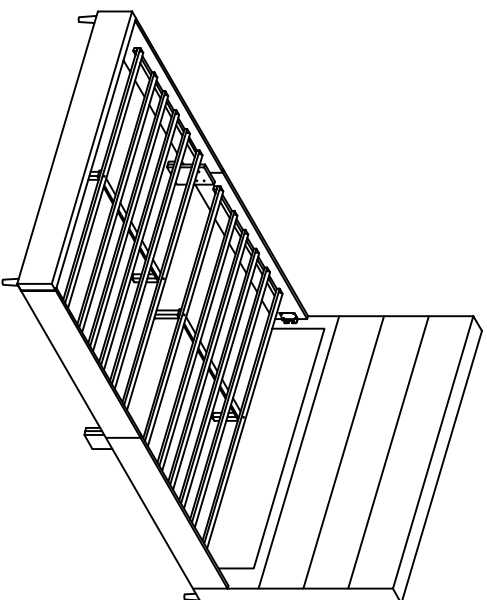

x4 RD393-287UK-FLEG - Footboard leg
Pattes de pied de lit
Patas del pie de cama *



x2 RD393-287UK-CLEG - Center support leg
Supports centraux
Soportes centrales *



x2 RD393-287UK-SLAT - Slat
Lattes
Listones *



x4 RD393-287UK-SULEG - Slat Support Legs
Pattes de supports
Patas de apoyo de listones *



x2 RD393-287UK-CERAI - Center Rail
Rail Central
Carril Central *

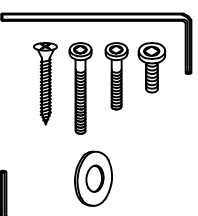

x1 RD393-287UK-HWKIT - Hardware kit list
Liste des pièces de quincaillerie
Lista del kit de materiales *

* Replaceable Part

Protect Your Wood or Laminate Flooring

*This statement applies to any floor without carpet.

If not careful, all furniture including upholstery and case pieces can scratch, scuff and even gouge floors. The recommendation is to have felt, rubber pads or area rugs under furniture on flooring without carpet.

Moving your furniture

Pushing and dragging furniture over floors without carpet can lead to scratches and scuffs. Have someone help when moving the larger pieces of furniture by lifting, try using a dolly or moving pads.

Felt and rubber pads

Applying furniture pads to the feet of furniture helps cushion contact points. Furniture pads can be found at local hardware stores. Felt pads slide easily across the floor, making them ideal for dining chairs and other pieces that move with use. Rubber pads will help furniture stay in place and are perfect for larger pieces, like sofas and loveseats.

Area rugs and rug pads

Using an area rug under furniture is another way to protect your floor from scratches and scuff marks. A rug pad under the area rug will provide extra cushion and added protection.